



LUNAWOOD

**HORIZONTAL FACADE
INSTALLATION GUIDE**



WWW.LUNAWOOD.COM

Facade Horizontal Installation Guide

Please check and read carefully legal disclaimer and written instructions after the picture guidelines.

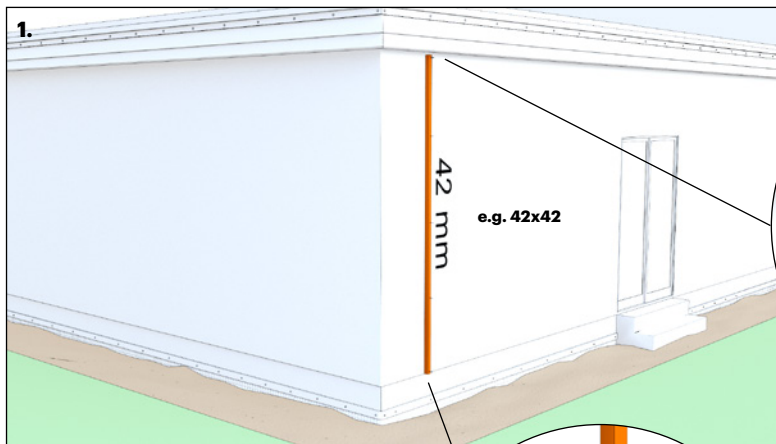

5X70 STAINLESS
STEEL SCREW FOR WOOD

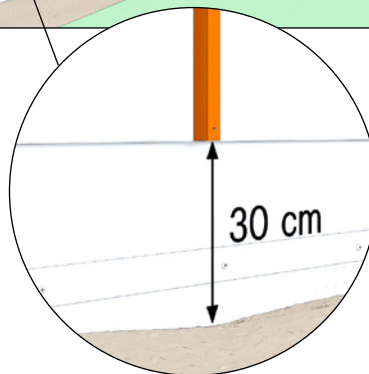

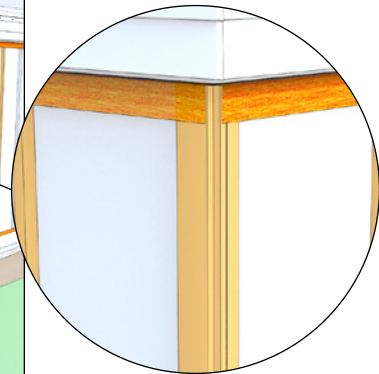
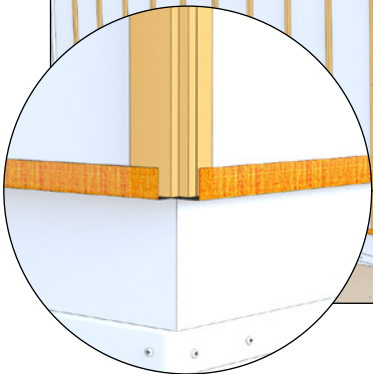
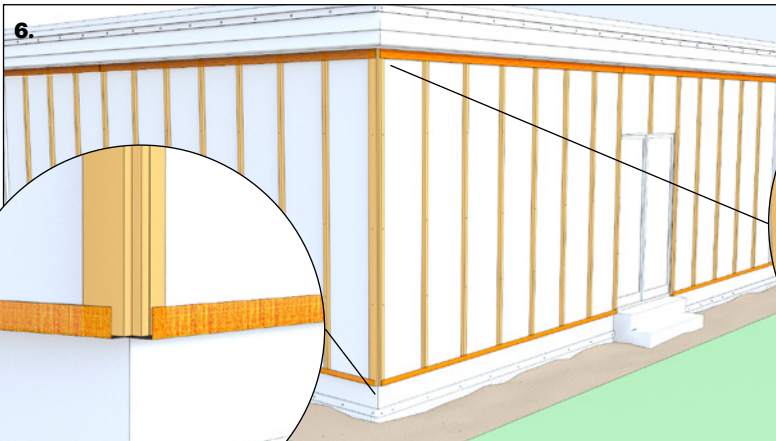
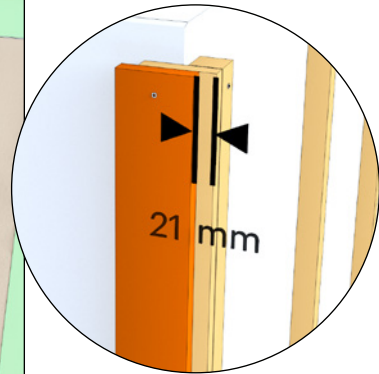
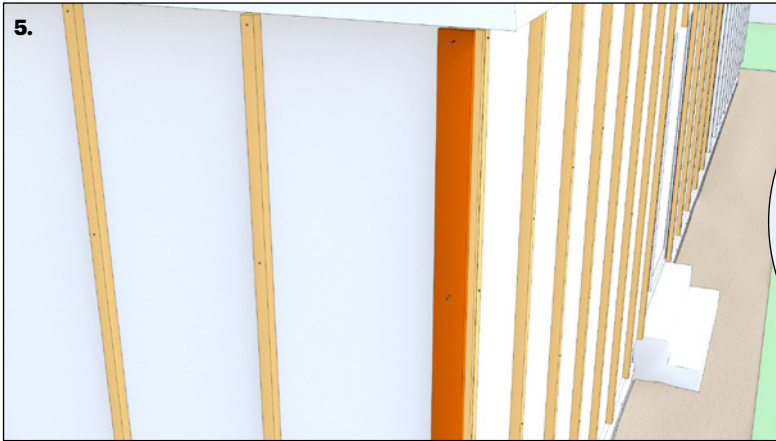

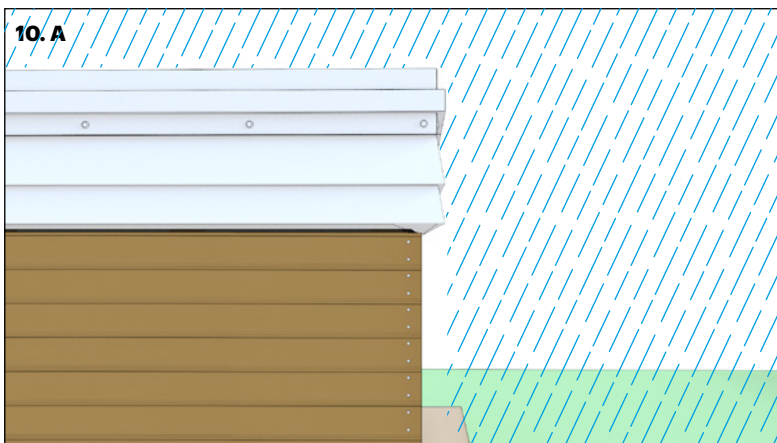
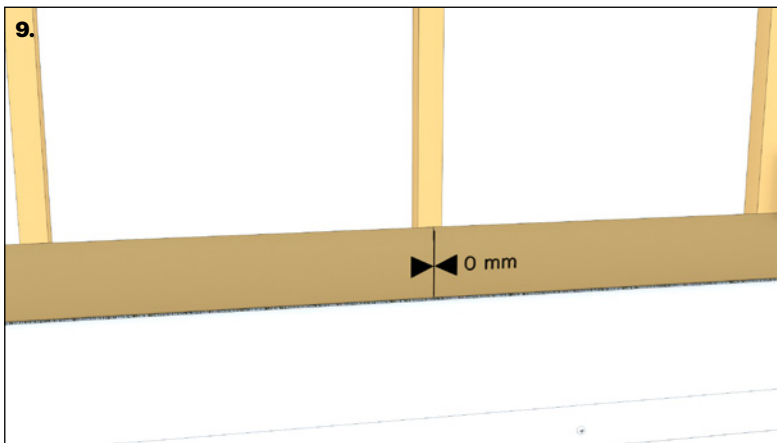
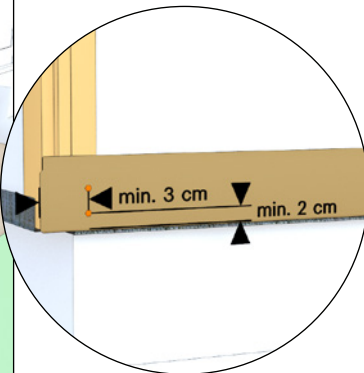
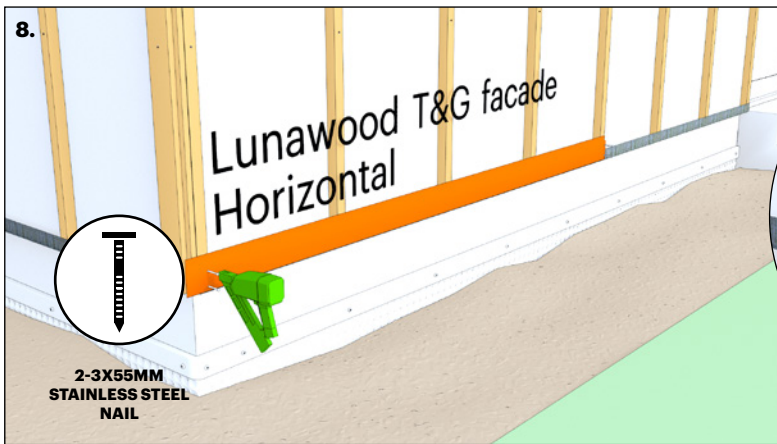
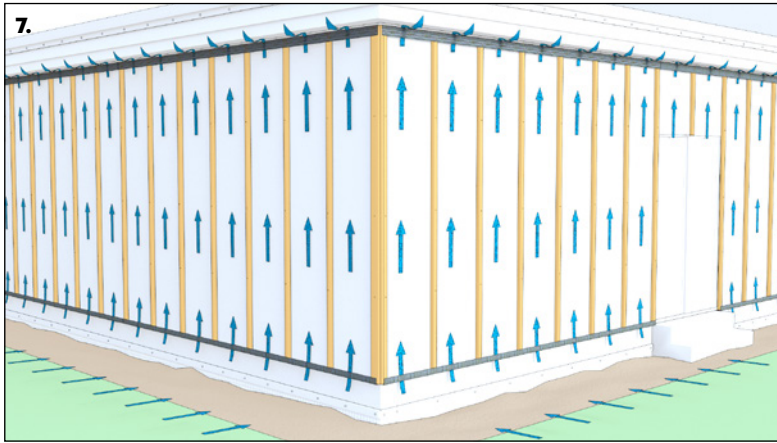

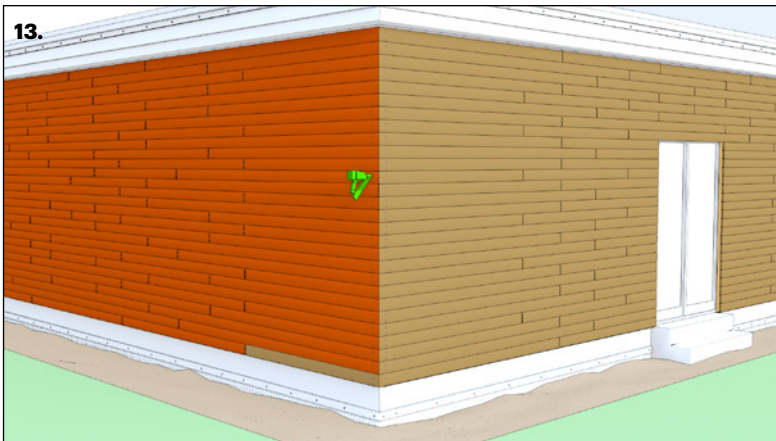
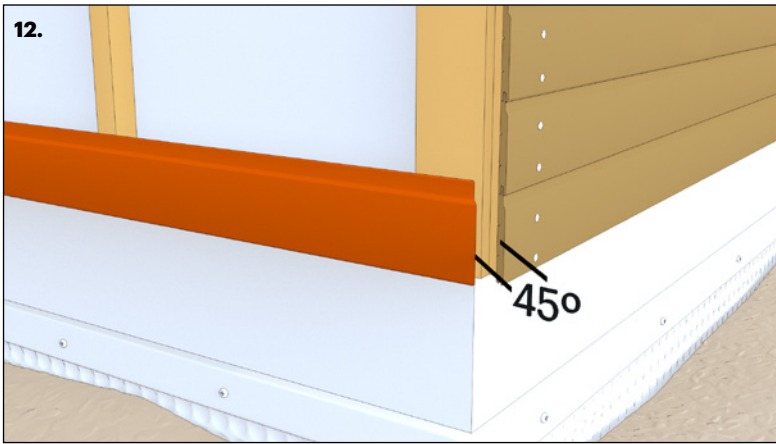
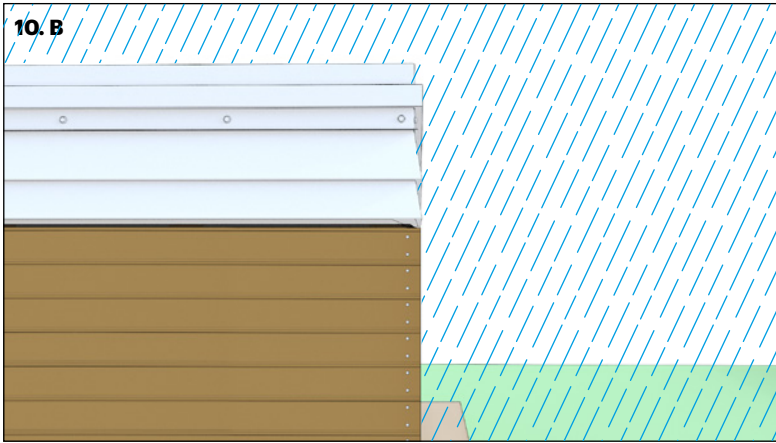

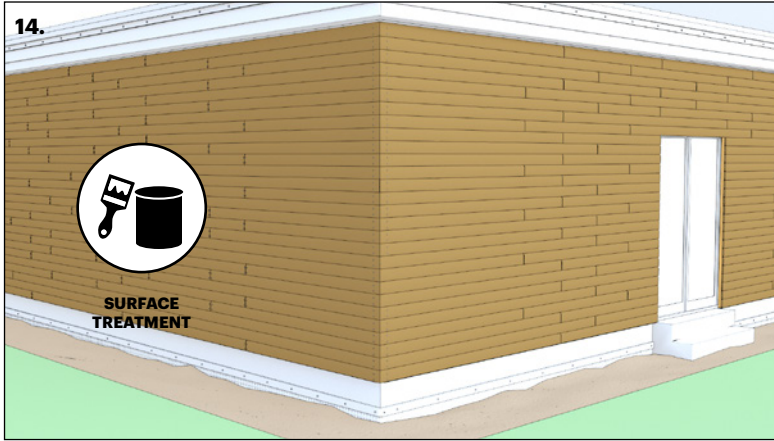

Most of the opaque paints and exterior cladding stains (with pigment included is suggested to keep the colour and protect from UV effects of the sun) are suitable for Lunawood. Please consult your local paint manufacturer. Surface treatment enables longer lifetime of the product

LEGAL DISCLAIMER – Lunawood horizontal and vertical cladding installation

BEFORE INSTALLATION

For best results, Lunawood exterior claddings should be protected from direct sunlight and weather before installation by covering the material and keeping it off of the ground.

Stainless steel screws or nails are required to properly fasten Lunawood claddings in order to have longer lifetime and no appearance of rust – if the board is installed through the face, two screws/nails per joist. When screwing through the face, a Standard miter and table saws with carbide-tipped, sharp blades are appropriate to use.

There must be adequate air circulation behind the façade in order to have long lasting Lunawood exterior facade. Please see guide in www.lunawood.com.

INSTALLATION

We suggest that the cladding boards are end-sealed after cutting with a clear, water resistant surface treatment. If end sealer is not used, the manufacturer has possibility to reject any claims under expected life cycle. To further protect Lunawood facade, we suggest facade to be finished with minimum water-based surface treatment prior or after installation. Please consult local paint manufacturer for the right surface treatment for your Lunawood exterior facade.

Our Cladding products are carefully manufactured and inspected to ensure quality. However, these are natural wood products and are subject to variations in weight, density, color, grain. Wood facade is naturally subject to dimensional changes as the moisture content in the wood fluctuates with humidity in the air. Swelling, shrinkage, surface checking, and other movement of individual pieces are normal occurrences in wood facades. Nevertheless, with Lunawood exterior claddings the swelling and shrinkage are minimal compared to Kiln Dried Scandinavian Pine or Spruce.

Local building codes must be consulted when building an exterior facades with Lunawood Tongue and Groove products. Most countries may require building permits. Please also see the animation of Lunawood exterior facade in www.lunawood.com and PDF guide in www.lunawood.com too.

Safety glasses and a dust mask should always be worn when working with Lunawood timber. We recommend an active carbon filter dust mask. Avoid splinters to hands and use gloves when installing. Drilling, sawing, sanding or machining wood products generates wood dust. Avoid inhaling wood dust or use a dust mask or other safeguards for personal protection.

Drawings and schematics used to show where to place screws and nails are for reference purposes only.

Exterior Facade must be built in accordance with regulatory requirements.

MAINTENANCE

Every exterior surface made from timber, needs regular maintenance. This means in practise; cleaning the surfaces with mold removal liquids and right amount of water (or simply soapy water) and let it dry. Use brush or similar. Avoid harming the actual surface of the exterior decking or facade or other end-use surface when cleaning. Consult your local professionals in exterior surface treatment installations or manufacturers. If exterior surfaces are not maintained regularly there will be surface mould, dirt, dust, soil, leaves, air impurities building up to the surfaces which will shorten lifetime of the exterior timber surface drastically.

Take care of the surface treatment also in regular basis to protect the wooden surface for having longer lifetime for Lunawood Exterior Claddings or Deckings.

OTHER INFORMATION

Every exterior Facade is different and this guide should not be considered to set out how a facade should be constructed in every circumstance. We accept no liability for any loss or injury caused by any reliance placed on this guide.

Lunawood reserves the right to update or revise the Terms and Conditions regarding installation guides in www.lunawood.com.

The entire content of the Site is protected by copyright. You may not copy, distribute, or create derivative works from any part of this Web site (including its graphics, pictorial matter, and text) without the prior written consent of Oy Lunawood Ltd unless otherwise expressly permitted by the Site.

Lunawood®; Lunawood TWPC and Lunawood Thermowood Plastic Composite and Profix are trademarks, service marks or trade names of Oy Lunawood Ltd and may not be used without prior written permission.

Any links on this document or Lunawood.com to third party Web sites are not an endorsement, sponsorship, or recommendation of the third parties or the third parties' ideas, products, or services. Similarly, any references in this Site or document to third parties and their products or services do not constitute an endorsement, sponsorship, or recommendation. If you follow links to third party Web sites, including the Web sites of any other companies affiliated or unaffiliated with Lunawood, you are subject to the terms and conditions and privacy policies of those sites, and Lunawood makes no warranty or representations regarding those sites. Further, Lunawood is not responsible for the content of third party or affiliated company sites or any actions, inactions, results, or damages caused by visiting those sites.

DISCLAIMER OF WARRANTIES

THE MATERIAL IN THIS WEB SITE OR IN THIS DOCUMENT IS PROVIDED "AS IS," WITHOUT ANY KIND OF WARRANTY. THE MATERIAL ON THIS WEB SITE IS NOT A WARRANTY AS TO ANY PRODUCT OR SERVICE PROVIDED BY OY LUNAWOOD LTD OR ANY SUBSIDIARIES.

LIMITATION OF LIABILITY

OY LUNAWOOD LTD IS NOT LIABLE FOR ANY ERRORS, DELAYS, INACCURACIES, OR OMISSIONS IN THIS SITE OR ANY SITES THAT ARE LINKED TO, OR REFERRED TO BY, THIS SITE. UNDER NO CIRCUMSTANCES SHALL OY LUNAWOOD LTD BE LIABLE FOR ANY DAMAGES, INCLUDING INDIRECT, INCIDENTAL, SPECIAL, OR CONSEQUENTIAL DAMAGES THAT RESULT FROM THE USE OF, OR INABILITY TO USE, THIS SITE WHETHER BASED ON ACTIONS IN CONTRACT, TORT, NEGLIGENCE, STRICT LIABILITY, OR OTHERWISE, EVEN IF OY LUNAWOOD LTD HAS BEEN ADVISED OF THE POSSIBILITY OF SUCH DAMAGE.

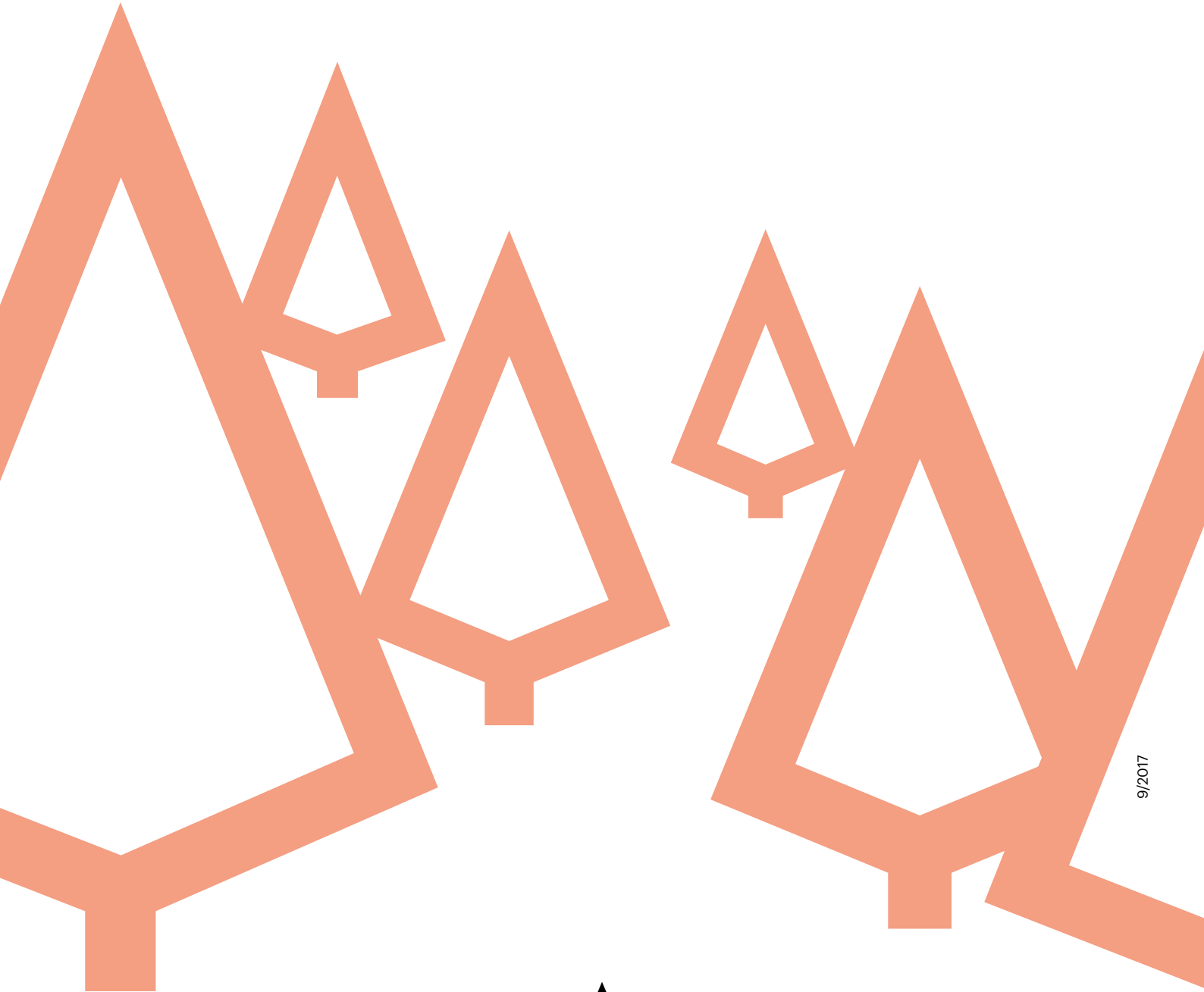

9/2017



WWW.LUNAWOOD.COM